

Panasonic

Voice Processing System

Subscriber's Guide

KX-TVS95/KX-TVS125

Model KX-TVS225/KX-TVS325



Thank you for purchasing the Panasonic Model KX-TVS95/KX-TVS125/
KX-TVS225/KX-TVS325 Voice Processing System.

Please read this manual carefully before using this product and save this manual
for future use.

Introduction

Thank you for purchasing the Panasonic Model KX-TVS95/KX-TVS125/
KX-TVS225/KX-TVS325 Voice Processing System.

The Panasonic Voice Processing System (VPS) is a powerful tool used to manage your voice communications and increase your productivity through the use of your voice mailbox. As a subscriber (the owner of a VPS mailbox), you can:

- Send a message to one or more people inside or outside of your office.
- Transfer messages (with your annotation) to other VPS subscribers.
- Receive messages from any touchtone telephone.
- Be called at an outside telephone or be notified through your beeper, when there are messages stored in your mailbox.
- Be notified by the message-waiting lamp on your extension that there are messages stored in your mailbox.
- Screen your calls.
- Create a "Personal Custom Service" for your callers.
- And more...

List of Enhancements

Compared to the KX-TVS90/KX-TVS120/KX-TVS220/KX-TVS320 Voice Processing System, these models are enhanced by the following new features:

- **Personal Custom Service**
Allows a subscriber to set the following Custom Services in her personal greeting (Personal Custom Service):
 - Transfer to Mailbox
 - Transfer to Extension
 - Transfer to Outside
 - Custom Service
 - VM Service (Voice Mail Service)
 - AA Service (Call Transfer Service)

A caller can select a desired service from those above while listening to the personal greeting or recording a message. (See 4.19 Setting Personal Custom Service.)

- **Subscriber Tutorial**
When a subscriber accesses her mailbox for the first time, the VPS guides her to set up the mailbox with some Help messages. Simply by following the messages, she can set up these items:
 - Password

- Owner's Name
- Personal Greetings (No Answer Greeting/Busy Greeting/After Hours Greeting)

(See 1.2 Subscriber Tutorial.)

- **Toll Saver**

Allows a subscriber to check her mailbox from a pre-assigned DID/ Caller ID number without necessarily making the VPS answer the call. Without Toll Saver, the VPS will always answer the call and therefore she will incur toll charges. With Toll Saver, the VPS can let her know that there are no new messages without answering her call. (See 4.18 Setting Telephone Numbers for Toll Saver.)

Getting Started

Numbers to Know

You must have the following information before you begin:

- The extension number(s) of the VPS.
- Your mailbox and extension number.
- The System Manager's phone number.

Basic Steps

When using your mailbox for the first time, you must read "Section 1:Mailbox Setup" and perform the key setup procedures described. You must customize your mailbox before sending or receiving messages.

Identify yourself as the owner of your mailbox by setting the following:

- Recording Personal Greetings
- Recording Your Name
- Setting Your Password



- This symbol identifies important notes about the operation being described.
- The voice prompt will guide you in every step of programming.
- Some features described in this manual are available with APT/ DPT Integration only. APT Integration is only available for the KX-TVS95.

Panasonic World Wide Web Address: <http://www.panasonic.com>

for customers in the United States or Puerto Rico.

Structure of the Manual

This manual consists of the following sections:

Section 1 Mailbox Setup

Describes the procedures for customizing your mailbox.

Section 2 Receiving Messages

Explains how to access and manage received messages.

Section 3 Sending Messages

Tells you how to send messages, including recording and delivery.

Section 4 Special Features

Describes how to set up the special features for your mailbox.

Appendix

Glossary

Table of Contents

1	Mailbox Setup	7
1.1	Logging in to Your Mailbox	7
1.2	Subscriber Tutorial.....	8
1.3	Changing and Erasing Personal Greetings.....	11
1.4	Changing and Clearing Your Password.....	13
1.5	Changing and Erasing Your Name	13
1.6	Service Access Commands.....	14
2	Receiving Messages	15
2.1	Receiving Messages.....	15
2.2	Replying to Messages.....	16
2.3	Message Transfer.....	17
2.4	Accessing Your Mailbox from an Outside Telephone.....	19
3	Sending Messages	20
3.1	Delivering Messages to Other Subscribers.....	20
3.2	Checking Mailbox Distribution.....	22
3.3	Setting up an External Message Delivery List	22
3.4	Sending External Delivery Messages	23
3.5	Receiving External Delivery Messages.....	25
3.6	Replying to External Delivery Messages	26
3.7	Checking and Setting External Message Delivery Status.....	26
4	Special Features	28
4.1	Call Transfer Status	28
4.2	Covering Extension.....	28
4.3	Incomplete Call Handling Status.....	29
4.4	Message Reception Mode	30
4.5	Personal Group Distribution Lists	31
4.6	Deleting Group Distribution Members.....	32
4.7	Deleting Group Distribution List Names.....	32

- 4.8 Message Waiting Notification..... 32
- 4.9 Interview Mailbox 35
- 4.10 Recording Personal Greetings for Caller ID..... 36
- 4.11 Assigning Caller ID Numbers for Personal Greeting for Caller ID..... 37
- 4.12 Personal Caller Name Announcement..... 38
- 4.13 Live Call Screening 40
- 4.14 Recording a Two-Way Conversation 40
- 4.15 Setting Telephone Numbers for Call Forwarding to CO 41
- 4.16 Remote Call Forwarding Set..... 42
- 4.17 Setting Telephone Numbers for Call Transfer to CO 44
- 4.18 Setting Telephone Numbers for Toll Saver..... 45
- 4.19 Setting Personal Custom Service 46
- A Appendix 49**
- A1 Quick Reference 49
- Glossary 50**

1 Mailbox Setup

1.1 Logging in to Your Mailbox

Before you access Subscriber Services, you must first open your mailbox.

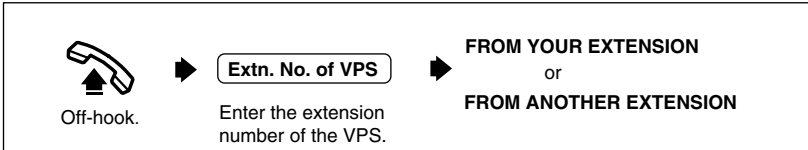

FROM YOUR EXTENSION
(When the Direct Mailbox Access is enabled)

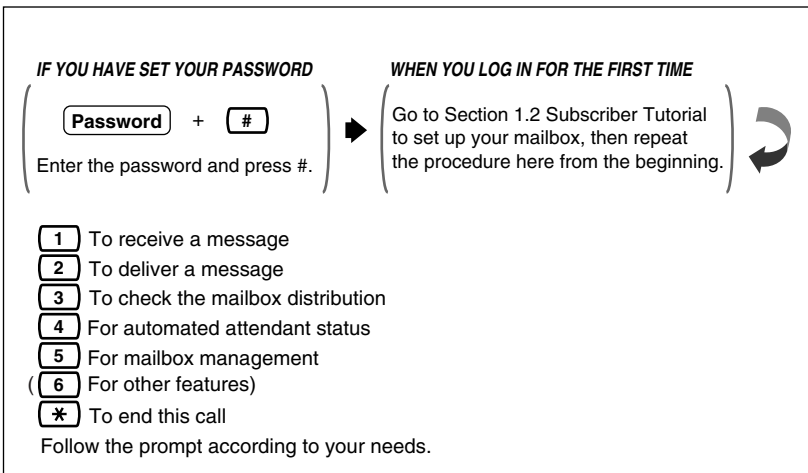

FROM ANOTHER EXTENSION

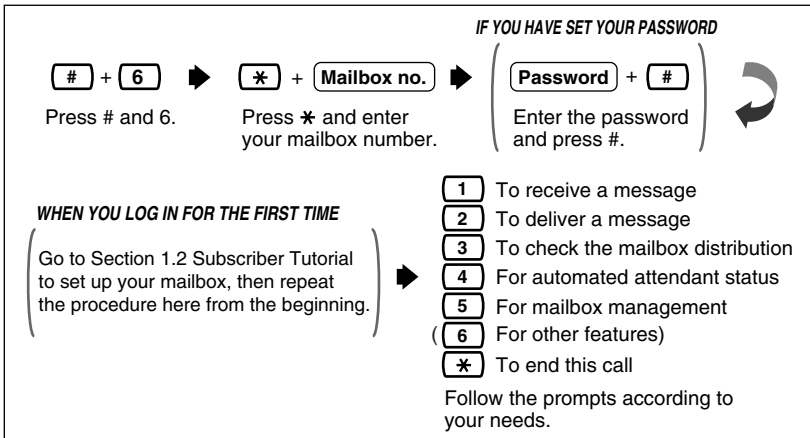

1.2 Subscriber Tutorial

When you access your mailbox for the first time, the VPS guides you to set up the mailbox with some Help messages. Simply by following the messages, you can set up these items:

- Password
- Owner's Name
- Personal Greetings (No Answer Greeting/Busy Greeting/After Hours Greeting)

Callers will hear your personal greeting message(s) after reaching your mailbox. If you set Personal Custom Service menus in your mailbox, you should record the appropriate greeting message(s) to guide callers to select a desired service (e.g., Transfer to Outside) among the preset Personal Custom Services (see 4.19 Setting Personal Custom Service). Personal greeting messages for Voice Mail Service are always followed by a tone and a chance to leave a message. Therefore, your personal greeting should say "please leave a message at the tone"; otherwise your callers may be confused.



- The System Administrator or the System Manager must authorize this feature before it can be used.
- You may be asked to enter a default password after logging into your mailbox. If you do not know this password, ask your System Administrator.

Subscriber's Main Menu → **IF NEEDED**

Log into your mailbox.

Default Password + **#**

Enter the default password and press #.

 Welcome to the Panasonic Voice Mail System. This is the Subscriber Tutorial service. In this service, you can set your password, record your name and record your personal greetings before you use this system...

Listen to the Tutorial Top Menu before setting up your mailbox.

SET PASSWORD

 You can set your password to a maximum of 10 digits...

Listen to the Help message to set your password.

SET OR SKIP YOUR PASSWORD FOR THE FIRST TIME

Password + **#** or **#** → **2**

Enter the password and press #, Press 2 to accept.
or press # to skip.

CHANGE OR CLEAR YOUR DEFAULT PASSWORD

1 → **New Password** + **#** or **#** → **2**

Press 1 to change. Enter the new password and press #, or press # to clear. Press 2 to accept.

RECORD OWNER'S NAME

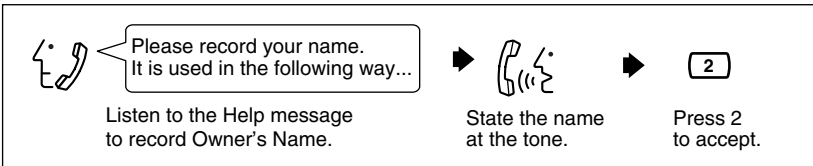

RECORD GREETINGS (NO ANSWER/BUSY SIGNAL/AFTER HOURS)

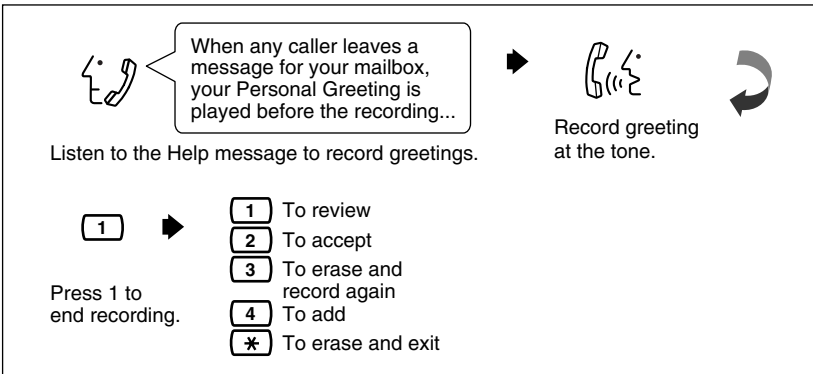

- If you decide to use the pre-recorded System Greeting, you need to erase the greeting you recorded here. See 1.3 Changing and Erasing Personal Greetings.

CONFIRM YOUR SETTINGS



- We strongly recommend that you set the password to 10 digits for maximum protection against hackers. Please avoid using obvious number combinations for the password.
- The VPS guides you to record No Answer Greeting, Busy Signal Greeting, and After Hours Greeting in this order.
- The Help message for Personal Greetings is only played when you record No Answer Greeting. It is not played for Busy Signal Greeting and After Hours Greeting.

1.3 Changing and Erasing Personal Greetings

After reaching your mailbox, callers will hear your personal greeting message(s). You can record 3 kinds of personal greetings: No Answer Greeting, Busy Greeting, and After Hours Greeting.

The VPS plays the appropriate message for each call.

Personal greeting messages for Voice Mail Service are always followed by a tone and a chance to leave a message. Therefore, your personal greeting should say "please leave a message at the tone"; otherwise your callers will be confused.

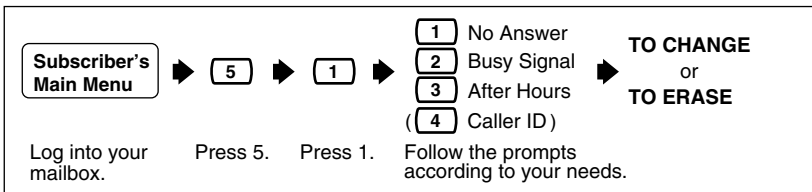

TO CHANGE

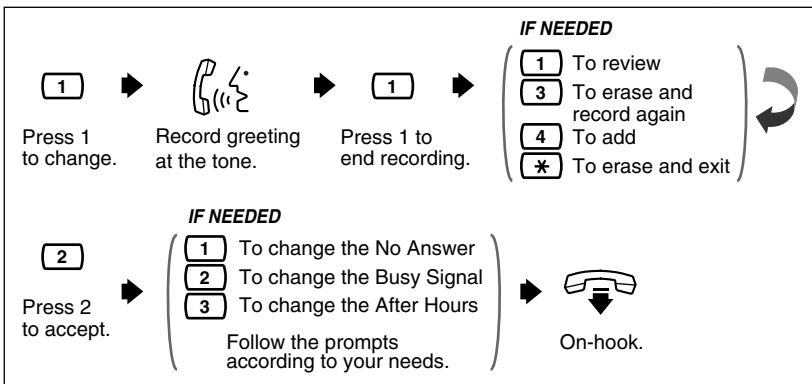

TO ERASE

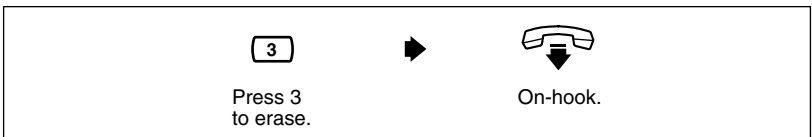



- Recording a Caller ID Greeting is available only when your COS parameter is enabled. To record a Caller ID Greeting, see 4.10 Recording Personal Greetings for Caller ID.
- Be sure to exit from the menu AFTER the greeting is accepted. Otherwise the greeting will not be stored.
- By system default, the maximum length of a personal greeting is 6 min.
- It is recommended that you mention your name in each personal greeting, because the regular announcement of name (see 1.5 Changing and Erasing Your Name) will be suppressed.

1.4 Changing and Clearing Your Password

The VPS provides the option of assigning a password to your mailbox to protect the messages stored there from unauthorized access. A password should be no longer than 10 digits (using the keys 0-9). You can change your password at any time. When setting your password, avoid using obvious number combinations. If you forget your password, have your System Administrator or System Manager clear it. You may then set a new one.

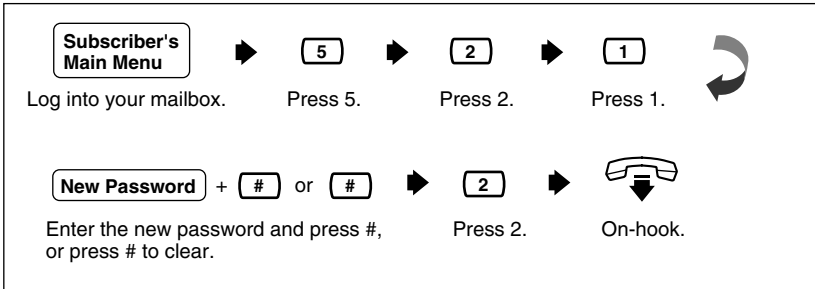

1.5 Changing and Erasing Your Name

The recording of your name informs callers that they have reached the correct mailbox (for example, when transferring a message to a subscriber, they will hear the subscriber's name). In addition, if a caller does not know the mailbox number, she may specify the mailbox by entering the first 3 or 4 letters of the owner's name. The VPS will announce a series of recorded names from which the caller may select.

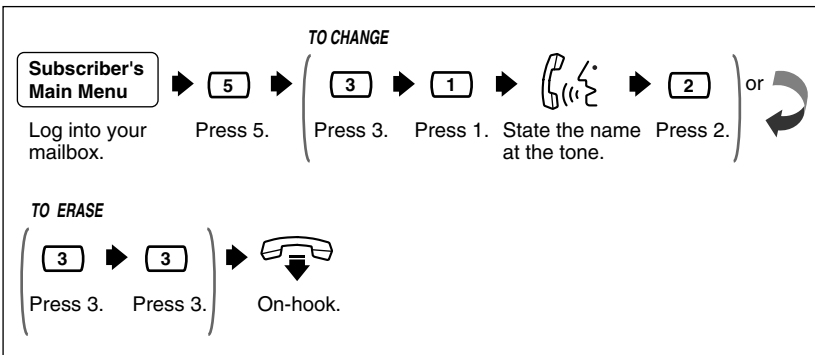

1.6 Service Access Commands

Before routinely using the VPS, you should familiarize yourself with the Service Access Commands shown in the Appendix.

The most important ones are the following:

- #2** — pressing this during system prompts activates Custom Service. It prompts you to access up to 100 Custom Service menus.
- #6** — pressing this during system prompts activates Voice Mail Service. You can record a message after entering a mailbox number at the prompt. You can also press * followed by your own mailbox number to log into your mailbox.
- #8** — pressing this during system prompts activates Automated Attendant Service. It prompts you for an extension number and then attempts to call your party. If she cannot take the call, the VPS will take some suitable action.

Note

If you call the extension directly, the VPS cannot help you.

- * — pressing this during system prompts takes you to the previous VPS menu. If you have lost bearings within Subscriber Service, use this command to get you out.
- 0** — pressing this lets you listen to the whole menu (for Help).

2 Receiving Messages

2.1 Receiving Messages

The VPS plays both the new and saved messages that are in your mailbox along with the date, time, and sender information pertaining to each message.

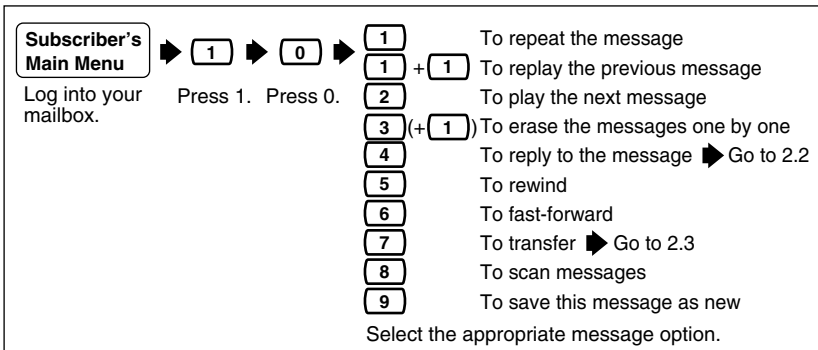

- When receiving your messages, you can skip the date, time, and sender information attached to each message by pressing **6**.
- It is possible to choose when to play the information attached to each message—"before" or "after" the message—or to choose "no playing" of the information. Please contact your System Administrator or System Manager for more explanation.
- **When all messages are scanned**, you will have 3 options
 - 1** To replay the previous message
 - 2** To play the next message
 - 3** To play the entire message
 Selection of option 3: "To play the entire message" can be carried out only once.
 If your System Administrator or System Manager has not enabled the Delete Message Confirmation feature to your mailbox (see "Delete Message Confirmation" in the Glossary), selecting option 3 a second time will erase the message.
- The VPS will automatically erase messages after a specified number of days. Your System Administrator or System Manager controls the number of days to maintain the messages.

2.2 Replying to Messages

This feature allows you to reply to the following types of messages:

- (1) Messages transferred or delivered to your mailbox by other subscribers
- (2) Messages with a Caller ID number



- To reply to (1), you can send a message to the message sender (other subscriber) or call her back. (The callback feature is available only when the message sender has an extension number.)
- To reply to (2), you can call back the message sender with the Caller ID number attached to the message (Caller ID Callback). The Caller ID Callback feature is available only if you are using a Panasonic KX-T series telephone system with APT/DPT Integration (see "APT Integration" and "DPT Integration" in the Glossary) and the System Manager has enabled this feature.

TO RECORD A MESSAGE

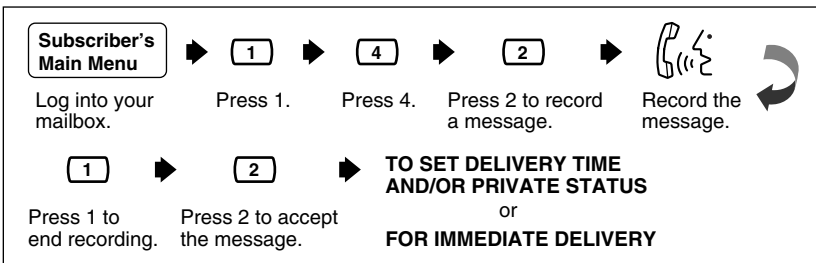

TO SET DELIVERY TIME AND/OR PRIVATE STATUS

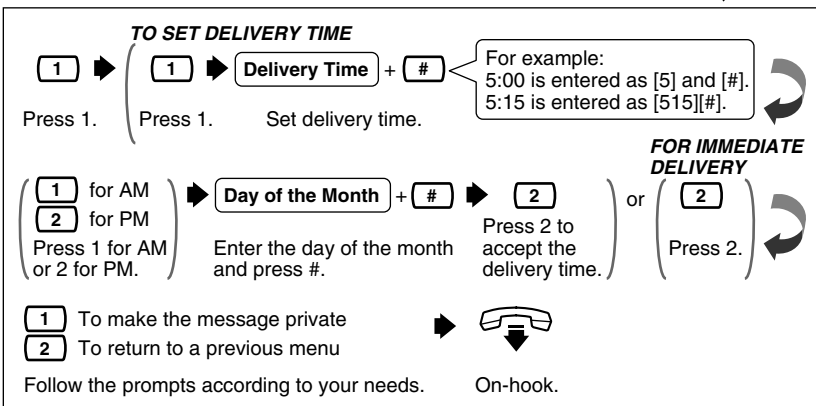

FOR IMMEDIATE DELIVERY

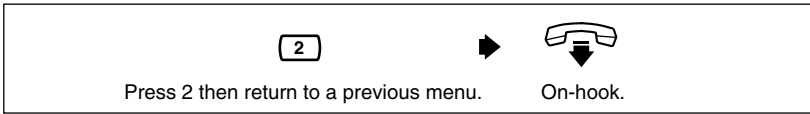

- If paused, the recording must be restarted within 20 s or the VPS will stop recording automatically.
- You will not hear " 1 for AM, 2 for PM" when the System Administrator has set the time stamp of User Prompts as "24-h".
- Note about the Day of the Month entry:
If today is February 16, and you enter 17#, the message will be delivered tomorrow.
If today is February 16, and you enter 5#, the message will be delivered March 5th.

TO CALL THE MESSAGE SENDER



2.3 Message Transfer

This function allows you to transfer messages to other mailboxes.

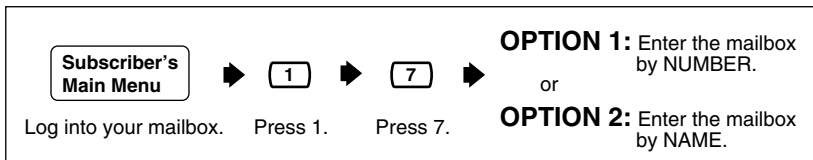

- You can also specify a Personal or a System Group Distribution List instead of an individual mailbox by entering the number of the list. If you use a Personal Group Distribution List, press [#] after the list number. Personal Group Distribution Lists must be created before they can be used (see 4.5 Personal Group Distribution Lists). To use a System Group Distribution List, check with the System Administrator to ensure that a list exists within the VPS.



OPTION 1: Enter the mailbox by NUMBER

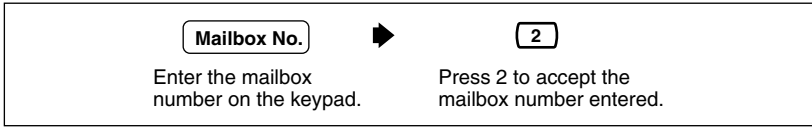

OPTION 2: Enter the mailbox by NAME

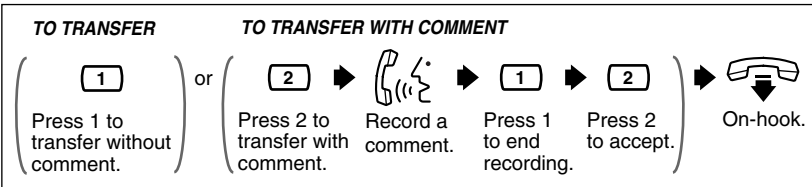
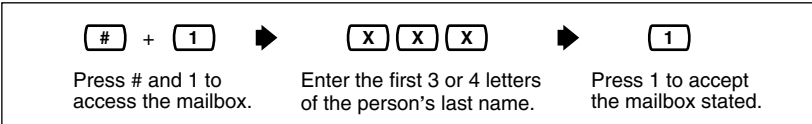

- No acknowledgment will be given that the message has been transferred.
- If the message is assigned as private, it cannot be transferred to other mailboxes.

2.4 Accessing Your Mailbox from an Outside Telephone

Follow this procedure to check your messages remotely.



- It may be possible for you to choose another language for Subscriber Service prompts. If you are interested in this option, please contact your System Administrator.

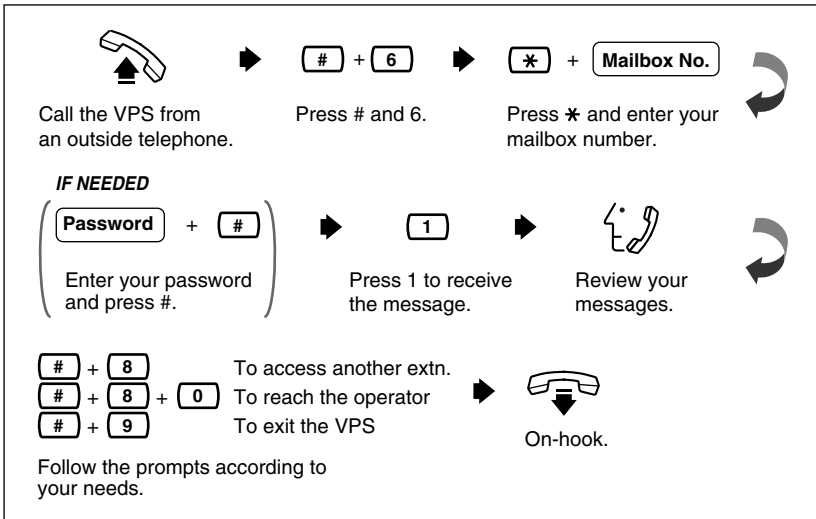

3 Sending Messages

3.1 Delivering Messages to Other Subscribers

Use this feature to send the same message to several other subscribers.

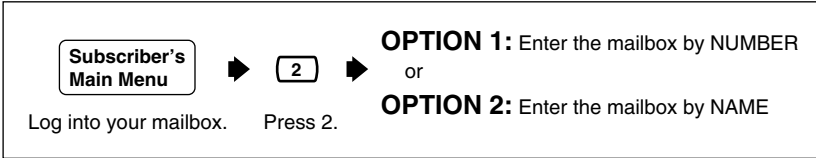

- You can also specify a Personal or a System Group Distribution List instead of an individual mailbox by entering the number of the list. If you use a Personal Group Distribution List, press [#] after the list number. Personal Group Distribution Lists must exist before they can be used. (See 4.5 Personal Group Distribution Lists). To use a System Group Distribution List, check with the System Administrator to ensure that a list exists within the VPS.



OPTION 1: Enter the mailbox by NUMBER

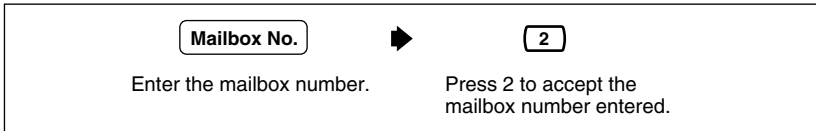

OPTION 2: Enter the mailbox by NAME

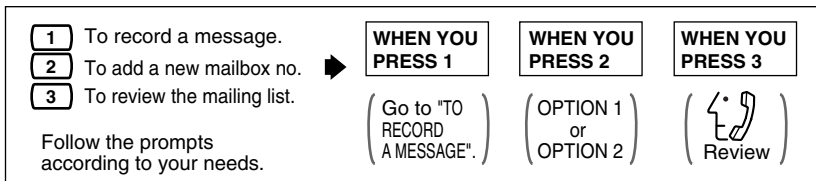
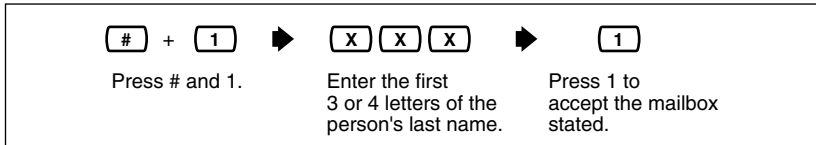



- You can specify a maximum of 20 mailboxes as destinations for 1 message.

TO RECORD A MESSAGE

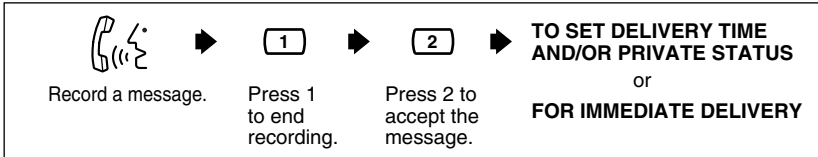

TO SET DELIVERY TIME AND/OR PRIVATE STATUS

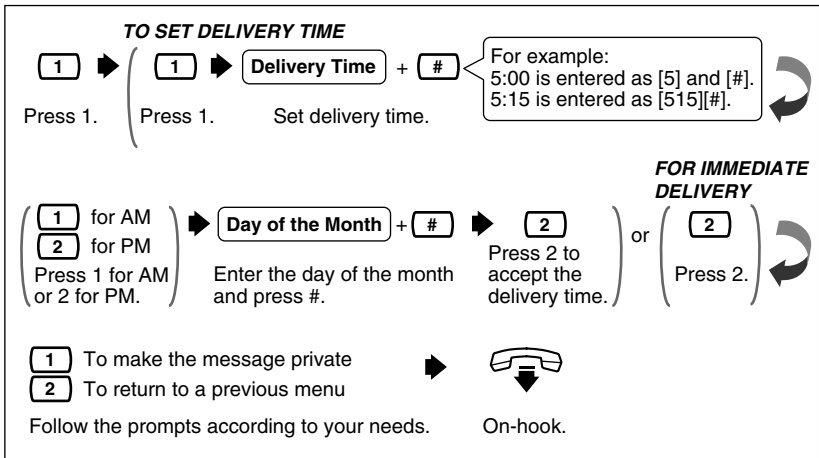

FOR IMMEDIATE DELIVERY

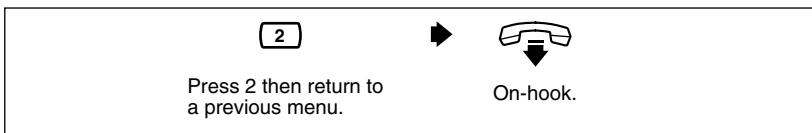



- If you pause during the recording, you must restart it within 20 s or the VPS will stop recording automatically.
- You will not hear " **1** " for AM, " **2** " for PM" when the System Administrator has set the time stamp of User Prompts as "24-h".
- See "**Note about the Day of the Month entry**" in Section 2.2 Replaying to Messages.

3.2 Checking Mailbox Distribution

This function allows you to check the status of messages, which you have recorded in your mailbox, for delivery to other mailboxes.



- You can check the delivery status of up to 84 message transmissions.

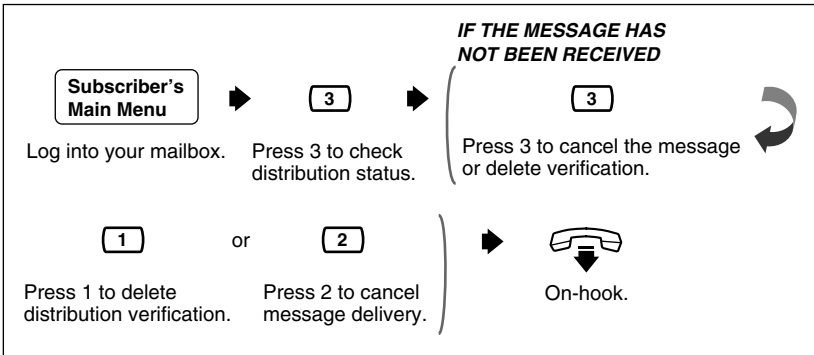

3.3 Setting up an External Message Delivery List

Setting up an External Message Delivery List lets you send the same message to several outside parties and/or extensions with a single operation. Up to 2 lists can be maintained at the same time, and each list can contain up to 8 members.



- The System Administrator or the System Manager must authorize this feature before it can be used.

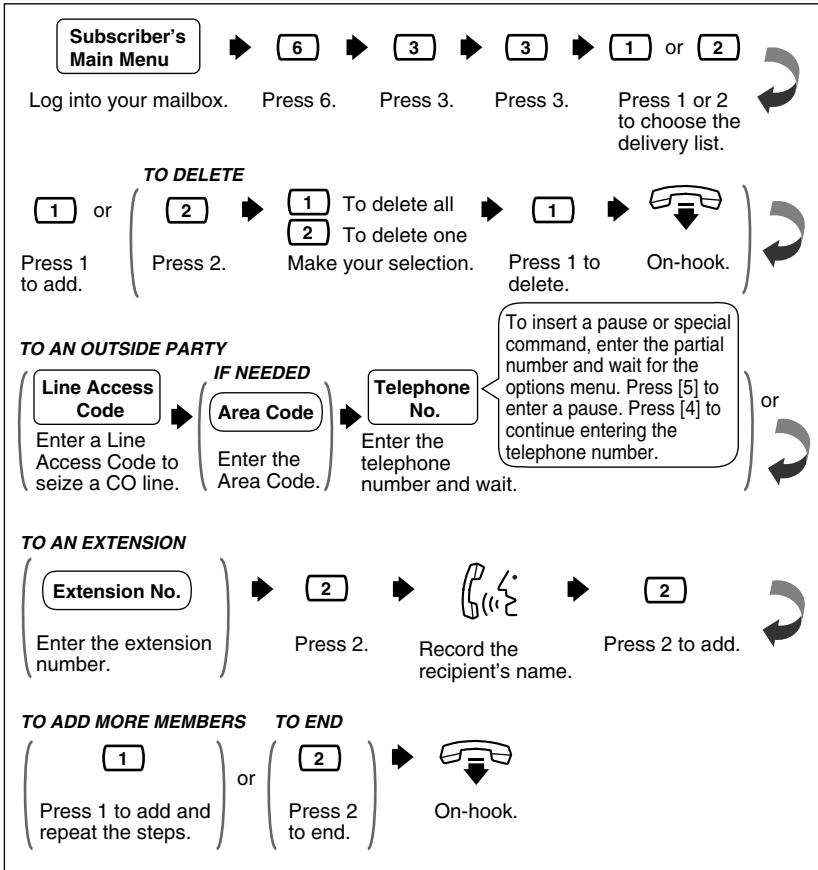

3.4 Sending External Delivery Messages

Use this feature to record and send external delivery messages.



- The System Administrator or the System Manager must authorize this feature before it can be used.
- Moreover, External Message Delivery has various limits (retry times, message length, max. messages for mailbox, etc.). If you have a problem, please contact your System Administrator.

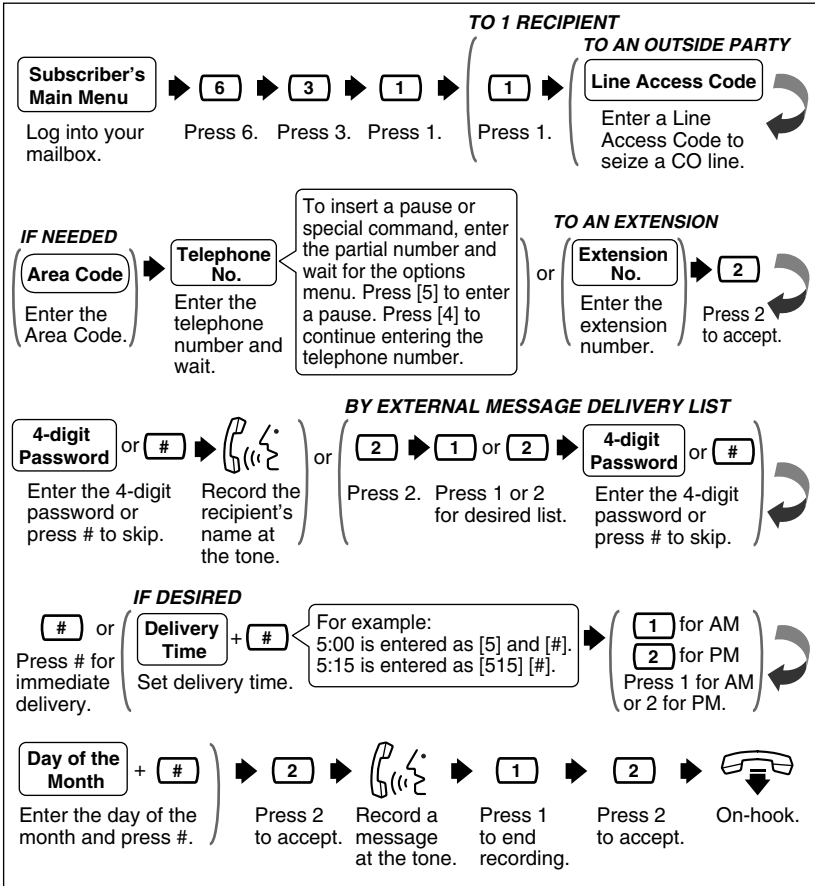



- The 4-digit password is not your password to log into your mailbox. You can decide it freely each time you send an external delivery message. Be sure to share the 4-digit password with the message receiver.
- You will not hear " **1** for AM, **2** for PM" when the System Administrator has set the time stamp of User Prompts as "24-h".
- See "**Note about the Day of the Month entry**" in Section 2.2 Replying to Messages.
- **Important Note:** When the VPS calls to a CO line via a PRI (ISDN Primary Rate Access Interface) card of a Panasonic PBX, please be sure to add "#" after the telephone number (1112223333 in the example here):
Example: 9P1112223333#
Please contact your System Administrator for more explanation.

3.5 Receiving External Delivery Messages

Use this feature to receive External Delivery Messages.

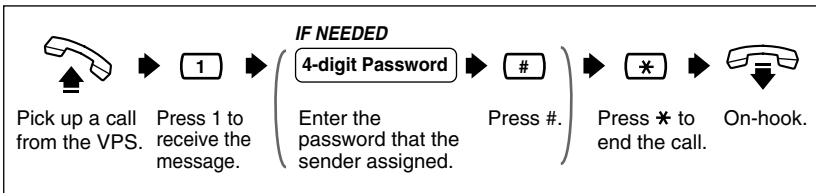

- The message will not be delivered if the password is incorrectly entered 3 times; however, the receiver will hear the following information depending upon system programming of the VPS:
 - (1) If the Company Name is recorded, it will be played.
 - (2) If the Callback Telephone Number has been registered, it will be played.
 - (3) If the Extension of the Owner (i.e., sender) has been registered, it will be played.
 This information helps the receiver to track down the message (or sender) if the receiver cannot remember the password.
- It is possible for the receiver to be guided in a specified language (prompt). It is also possible for the receiver to select the language she wants. If you (as the sender of external messages) are interested in these options, please contact your System Administrator.

3.6 Replying to External Delivery Messages

Use this feature to reply to External Delivery Messages.

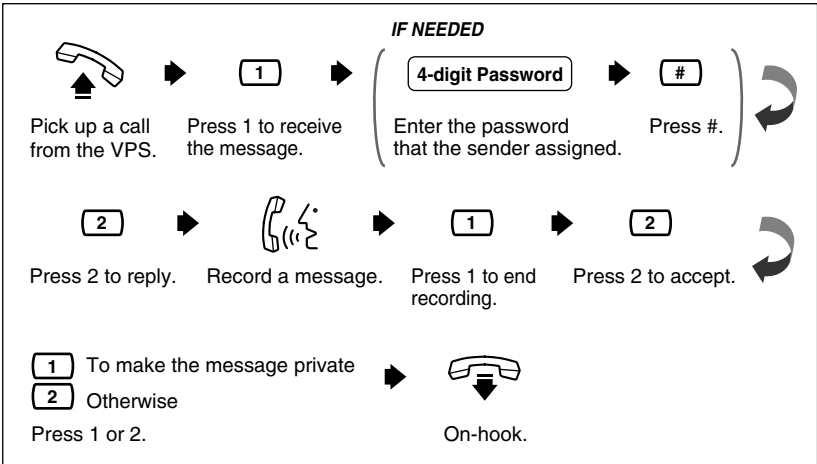

3.7 Checking and Setting External Message Delivery Status

After recording external delivery messages, you can check the delivery schedule or review the specified recipients. You can only check the delivery status (to, if you wish, cancel delivery or change the delivery time and date) of messages that have not yet been delivered. Included in "undelivered" messages are messages for which the recipient could not correctly enter the password. After listening, you have the option of deleting messages or changing schedules.



- The System Administrator or the System Manager must authorize this feature before it can be used.

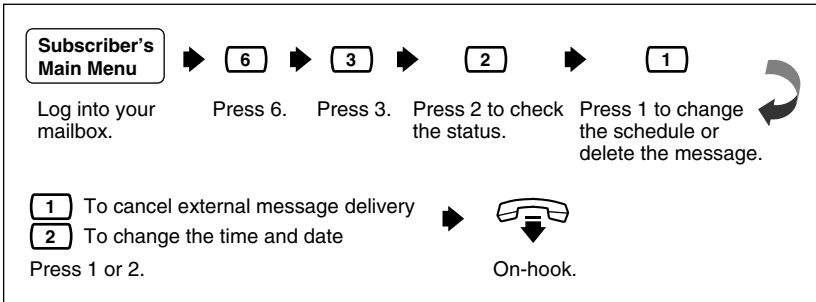

4 Special Features

4.1 Call Transfer Status

Use this feature to specify how the VPS should handle a call when a caller reaches your extension. The following options are available: Call Blocking, Call Screening, Intercom Paging, Calling a Beeper, Transfer to Mailbox or Disable All Transfer Services.

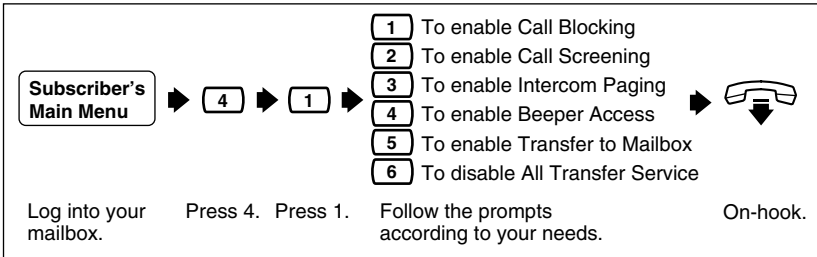

- The Intercom Paging feature is available only if you are using a Panasonic KX-T series telephone system with APT/DPT Integration (see "APT Integration" and "DPT Integration" in the Glossary).

4.2 Covering Extension

The caller goes to the covering extension in 3 ways:

- One way is via the Automated Attendant Service when the Incomplete Call Handling Status has enabled Covering Extension Transfer Status (see 4.3 Incomplete Call Handling Status).
 - The second way is during a Personal Greeting announcement—if the caller presses [0] while a Personal Greeting is being played, she is sent to the covering extension or to an operator (if the covering extension is not specified).
 - The third way is while recording a message—if the caller presses [0] while leaving a message, she is sent to the covering extension or to an operator (if the covering extension is not specified).
-
- To activate this feature, your System Administrator must assign a Covering Extension to your mailbox.



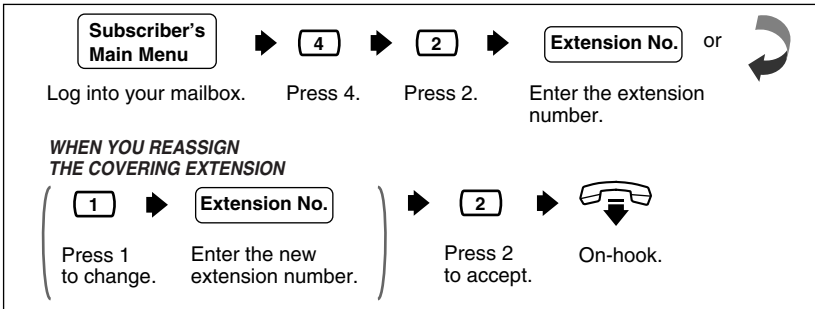

- The caller will not know to press [0] for transfer to your covering extension. Therefore, the caller must be instructed. For example, you might record the Busy Greeting in this way: "Hi, this is Cindy. Sorry, but I am busy with another call right now. If you press [0] now, you will be transferred to my secretary. Otherwise, please leave a message after you hear the tone".

4.3 Incomplete Call Handling Status

Calls are considered incomplete if there is no answer or if the line is busy. The Incomplete Call Handling Status has six options: (1) record a message from the caller; (2) transfer the caller to a covering extension; (3) page the mailbox owner by intercom (Intercom Paging); (4) notify the mailbox owner via a beeper; (5) transfer the caller to the operator; or (6) let the caller try another extension.

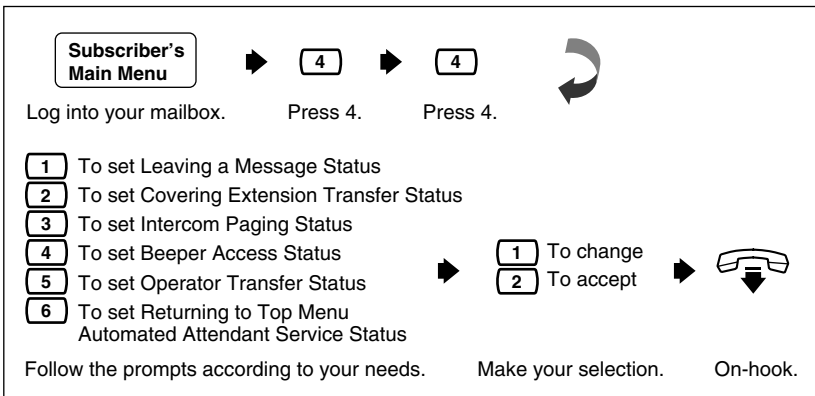

4.5 Personal Group Distribution Lists

Use the Personal Group Distribution List to send the same message to several mailboxes in a single operation. Up to 4 lists can be maintained with each list containing up to 20 mailbox members.

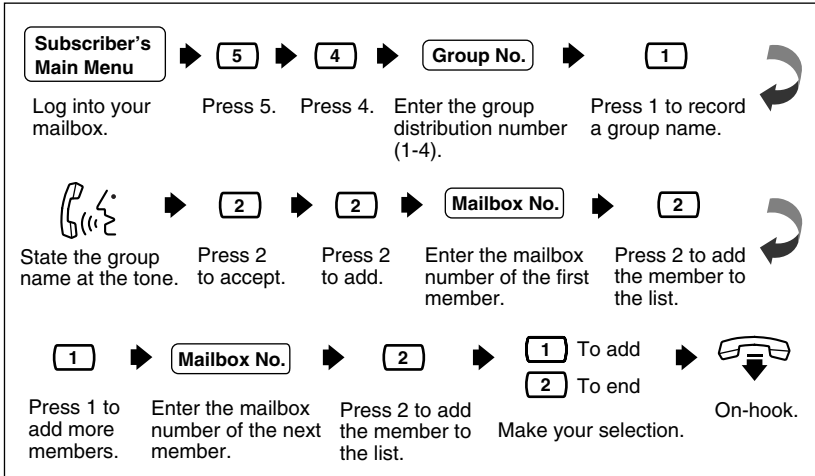

- To make use of Personal Group Distribution Lists, please see 3.1 Delivering Messages to Other Subscribers.
- Personal Group Distribution Lists are available to only one subscriber (you). If a list is to be shared among several subscribers, they should ask the System Administrator to create a System Group Distribution List or Lists.

4.6 Deleting Group Distribution Members

Use this feature to delete group members from a Group Distribution List. You can delete the members individually or altogether.

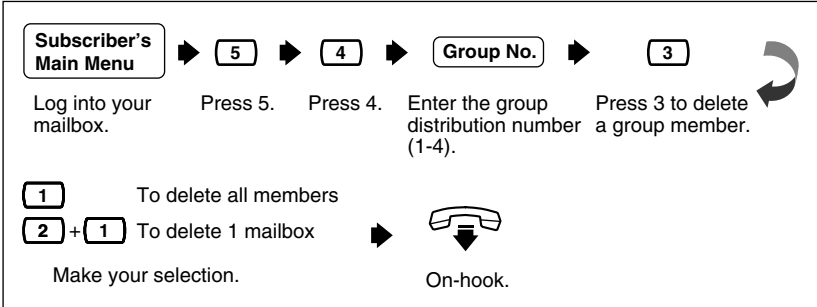

- Press **1** to delete all members. Press **2** to review all members one by one—in each case, you can delete a member, or skip it. Just follow the prompts.

4.7 Deleting Group Distribution List Names

Use this feature to delete a group distribution list name.

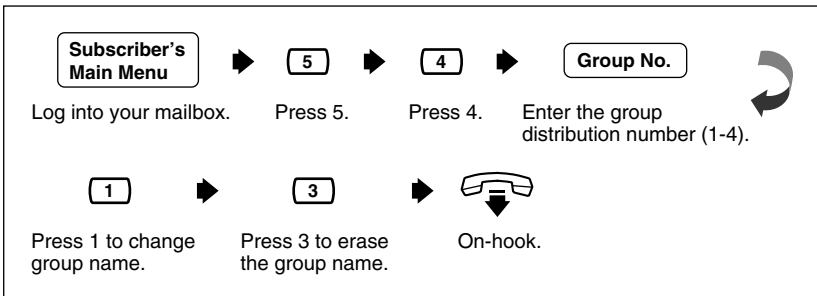

4.8 Message Waiting Notification

The VPS is able to notify you when a new message has been recorded in your mailbox. There are 3 ways by which the VPS notifies you: (1) Message Waiting Lamp on your proprietary telephone, (2) a call to another telephone (e.g., your cell phone), or (3) your beeper. You can assign time frames to each of these devices.

The VPS is also able to notify your beeper with the callback number of the party who left the message. The telephone number stored on the VPS for your beeper must include the beeper display command.

Three features can be set for message waiting notification: Message Waiting Lamp Status, Change Device Status, and Assign Telephone Number. These features can be set by the System Administrator or at a subscriber telephone. You must enter a distinct phone number to each device.



- The System Administrator or the System Manager must authorize this feature before it can be used.
- **Message Waiting Lamp Notification Setting**
The VPS illuminates the message waiting lamp of your extension when your mailbox has a new message recorded.
- **Setting Device Status**
For each device, the notification can be continuous, disabled, or enabled to a preset schedule. Only the System Administrator can set the notification to a preset schedule.
- **Notification Number Assignment**
You can set up to 3 telephone or beeper numbers to ring when you wish to receive notification calls.

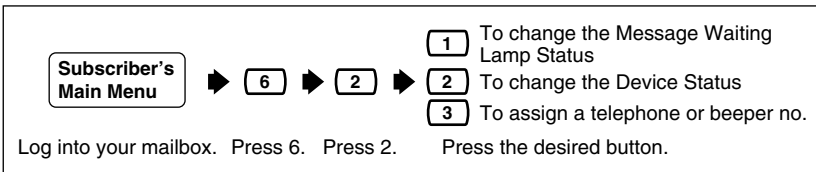

WHEN YOU PRESS 1

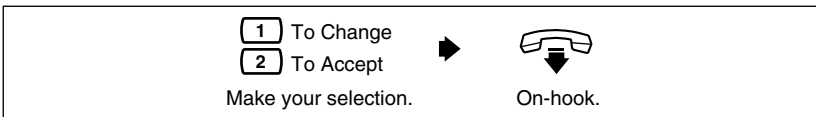

WHEN YOU PRESS 2

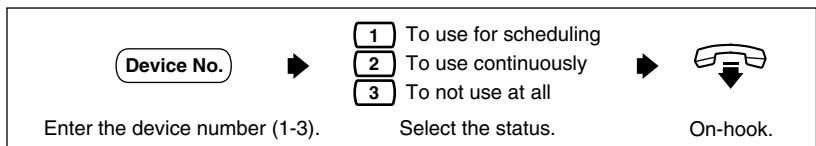

WHEN YOU PRESS 3

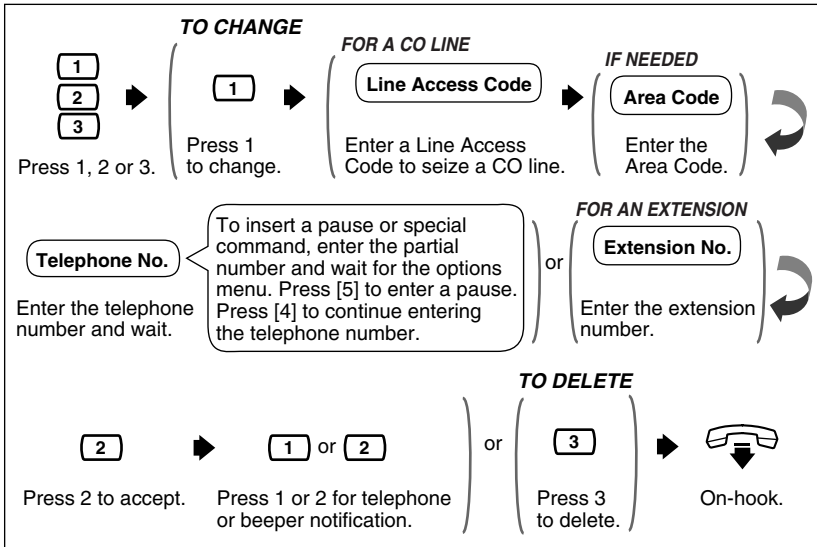

- If you do not know your line access code, ask your System Manager.
- You will hear the following guidance as the Options Menu:
 - To change, press **1**.
 - To accept, press **2**.
 - To review, press **3**.
 - To add more digits, press **4**.
 - To insert a pause, press **5**.
 - To set dial mode, press **6**.
 - To insert a wait for dial mode, press **7**.
 - To insert a beeper display command, press **8**.
- **Important Note:** When the VPS calls to a CO line via a PRI (ISDN Primary Rate Access Interface) card of a Panasonic PBX, please be sure to add "#" after the telephone number (112223333 in the example here):
 Example: 9P112223333#PP123PP456PPX#
 Please contact your System Administrator for more explanation.

4.9 Interview Mailbox

An Interview Mailbox plays prerecorded questions to callers and records their answers. You can record up to 10 questions and set the answer lengths from 4 s to 32 s. The answers are recorded and stored, in order, in your mailbox. You must set the answer length and record the questions.



- To activate this feature, your System Manager or System Administrator must assign an Interview Mailbox to your mailbox.
- One way to make your Interview Mailbox easily accessible to callers is to ask the System Administrator to add your Interview Mailbox as a keypad option to a Custom Service menu. Callers can be guided to this menu in any language.

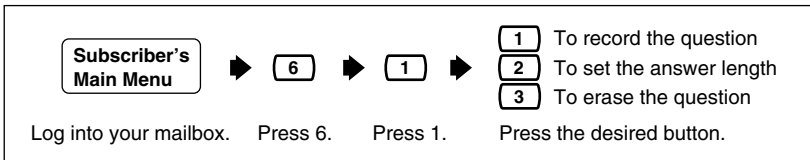

WHEN YOU PRESS 1

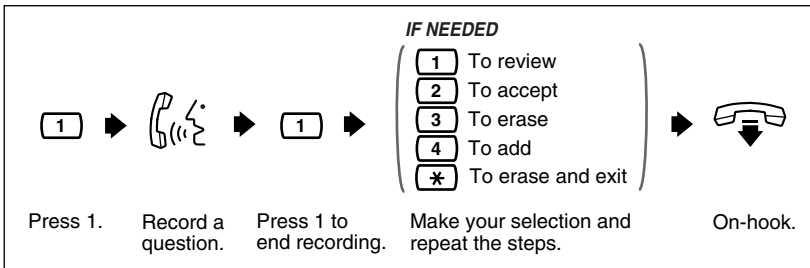

WHEN YOU PRESS 2

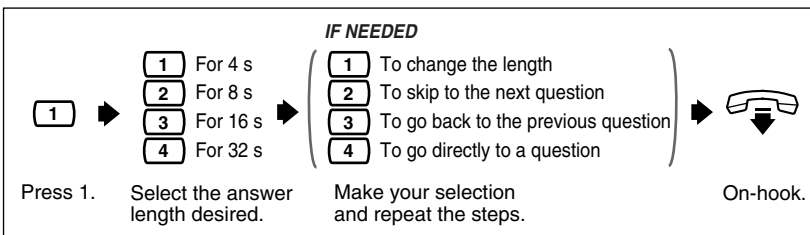

WHEN YOU PRESS 3

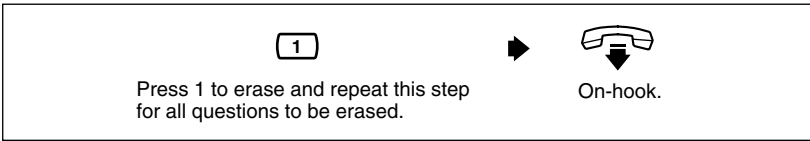

4.10 Recording Personal Greetings for Caller ID

This feature allows you to record up to 4 personal greetings for calls from assigned Caller ID numbers. Each personal greeting supports up to 8 Caller ID numbers. To enable this feature, first record a greeting, then assign Caller ID numbers. To assign Caller ID numbers, see 4.11 Assigning Caller ID Numbers for Personal Greeting for Caller ID.



- This feature is available to you only if you are using a Panasonic KX-T series telephone system with APT/DPT Integration (see "APT Integration" and "DPT Integration" in the Glossary).
- If you cannot use this feature, ask your System Administrator or System Manager. She might have disabled it.

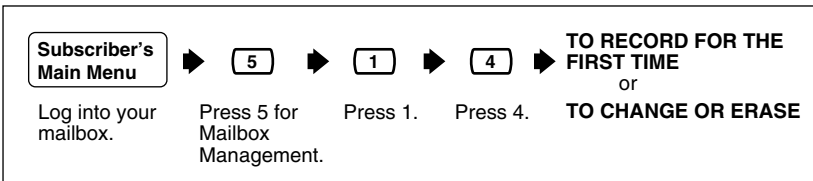

TO RECORD FOR THE FIRST TIME

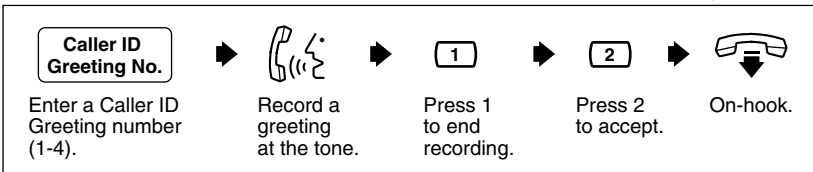

- You can go on to assign Caller ID numbers after accepting the recorded greeting.

TO CHANGE OR ERASE

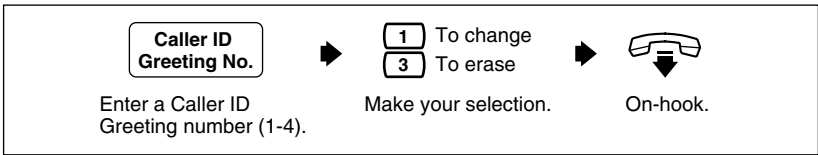

- When you change the greeting, follow the steps in "TO RECORD FOR THE FIRST TIME" to rerecord.

4.11 Assigning Caller ID Numbers for Personal Greeting for Caller ID

Use this feature to assign Caller ID numbers for prerecorded personal greetings. Each greeting supports up to 8 Caller ID numbers.



- To assign Caller ID numbers, first record a personal greeting (see 4.10 Recording Personal Greetings for Caller ID).

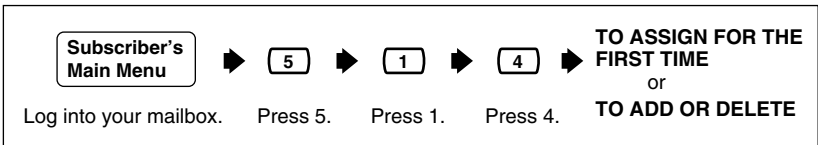

TO ASSIGN FOR THE FIRST TIME

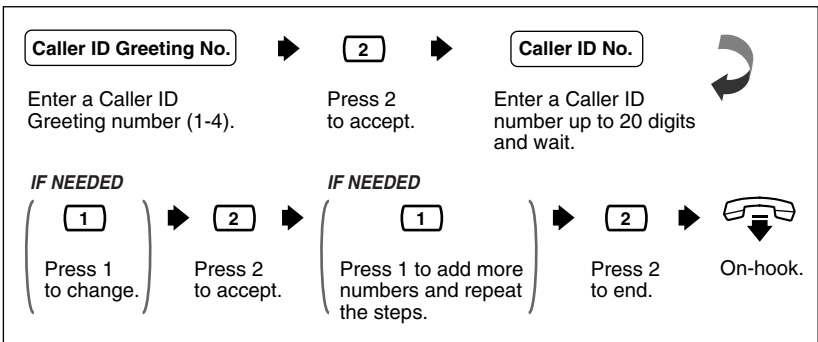



- For the Caller ID Number, you can use "*" as a wild card. For example, if you assign "021 (area code) * * * * * *", calls from area code "021" will hear the same greeting.
- If you enter a number which you have already assigned, the prompt notifies you. Follow the prompt and enter another number.

TO ADD OR DELETE

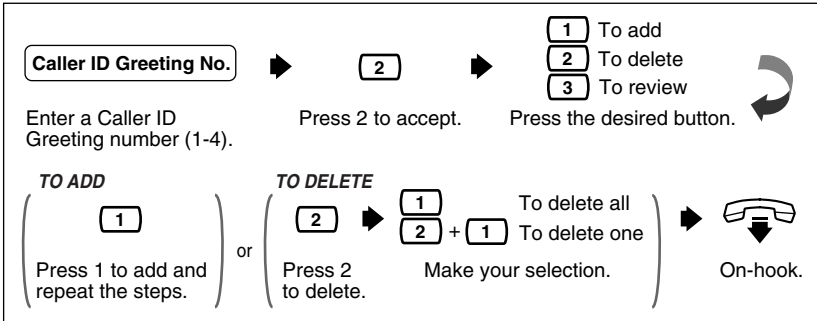

- When you add a Caller ID number, follow the steps in "TO ASSIGN FOR THE FIRST TIME" to assign.

4.12 Personal Caller Name Announcement

This feature allows you to assign up to 30 Caller ID numbers and record a caller name for each Caller ID number from your telephone. The caller name is announced when: (1) you listen to the messages from assigned numbers left in your mailbox, (2) the VPS transfers the calls from assigned numbers to you (Caller ID Screening), and (3) the VPS pages you by intercom (Intercom Paging).



- This feature is available to you only if you are using a Panasonic KX-T series telephone system with APT/DPT Integration (see "APT Integration" and "DPT Integration" in the Glossary).
- The System Administrator or the System Manager can change the maximum number of Caller IDs for the Personal Caller Name Announcement for your extension.
- If Caller ID Screening does not work, consult your System Administrator or System Manager. She might have disabled it.
- If you enter a number which you have already assigned, the prompt notifies you. Follow the prompt and enter another number.

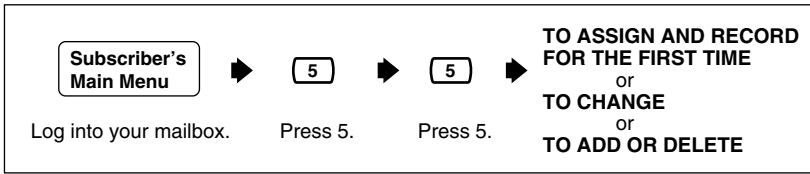

TO ASSIGN AND RECORD FOR THE FIRST TIME

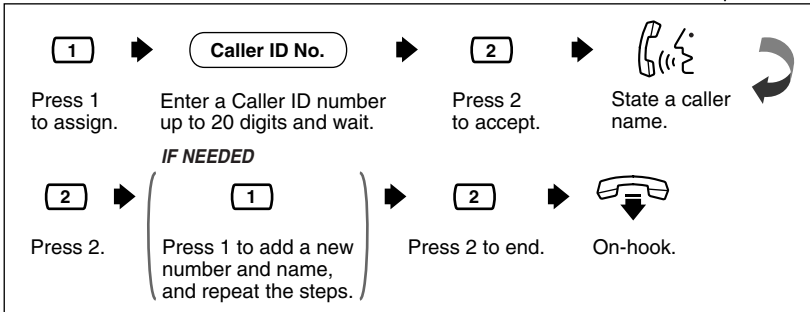

TO CHANGE

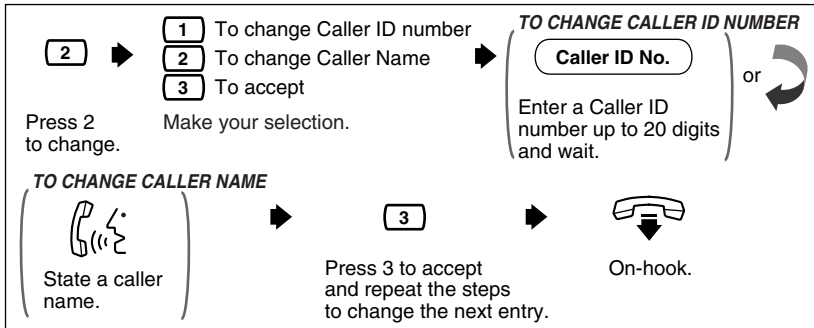

TO ADD OR DELETE

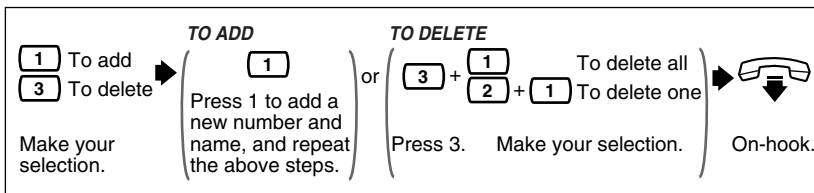

4.13 Live Call Screening

By assigning one of your telephone keys to this feature, you can monitor incoming calls that have been forwarded to the Voice Mail Service.

When in the Hands-Free Mode, you can monitor the incoming call through the telephone's built-in speaker. You can speak with the caller by picking up the handset.

When in the Private Mode, you can monitor the incoming call through the handset after you hear the notification tone. You can speak with the caller by pressing the feature key or you can stop listening to the message by replacing the handset.



- This feature is available to you only if you are using a Panasonic KX-T series telephone system with APT/DPT Integration (see "APT Integration" and "DPT Integration" in the Glossary), and if the System Administrator has provided your extension with this feature.
- For detailed information concerning this feature, please refer to the documentation of your Panasonic KX-T series telephone system.

4.14 Recording a Two-Way Conversation

By assigning one of the function keys on your telephone to this feature, you can record the conversation that you are having.

You must always notify the other party before you begin recording.

There are 3 types of conversation recording, and hence 3 types of function keys:

(1) Two-Way Recording (TWR)

Record into your own mailbox.

(2) Two-Way Transfer (TWT)

Record into another subscriber's mailbox.

(3) One-Touch Two-Way Transfer (One-Touch TWT)

Record into another subscriber's mailbox with one touch.

(Available only with KX-TDA/KX-TAW series.)

Normally, conversation recording time is limited. However, there is an "Unlimited Message Length" option. Call your System Administrator for assistance.



- This feature is available to you only if you are using a Panasonic KX-T series telephone system with APT/DPT Integration (see "APT Integration" and "DPT Integration" in the Glossary).
- For the instructions of how to use this feature, please refer to the User Manual of your Panasonic KX-T series telephone system.

4.15 Setting Telephone Numbers for Call Forwarding to CO

This feature allows you to assign Telephone number 1 and Telephone number 2 as the destination to which the callers are forwarded if you set Remote Call Forwarding to a CO line (see 4.16 Remote Call Forwarding Set).



- This feature is available to you only if you are using a Panasonic KX-T series telephone system with DPT Integration (see "DPT Integration" in the Glossary).
- If you cannot use this feature, ask your System Administrator or System Manager. She might have disabled it.

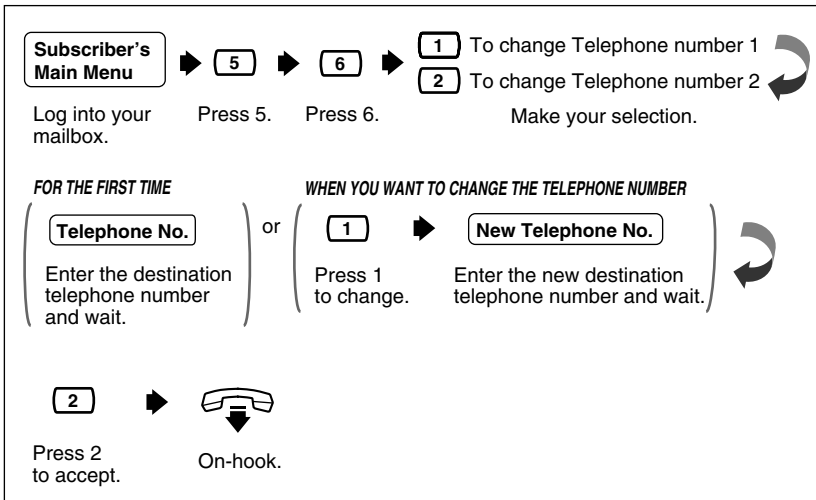



- Depending on your telephone system, you can enter up to 16 or 24 digits using the keys 0-9 and * for telephone numbers.
- Please make sure you begin the telephone number with a Line Access Code (to seize a CO line).
- **Note about telephone number assignment and call forwarding setting:**
The Remote Call Forward to CO feature only allows you to assign Telephone number 1 and/or Telephone number 2; to enable call forwarding to the telephone number you have assigned above, follow the instructions in 4.16 Remote Call Forwarding Set.
- If you should change the telephone number after you have enabled call forwarding to a CO line, you must go back to 4.16 Remote Call Forwarding Set to reset the call forwarding setting; otherwise, you will be transferring calls to the old telephone number unknowingly.

4.16 Remote Call Forwarding Set

This feature allows you to program your extension from a remote location to forward various types of calls to a desired extension or an outside telephone. There are 6 forwarding settings available: Forward All Calls, Forward Busy Calls, Forward No Answer Calls, Forward Busy or No Answer Calls, Forward to a CO Line, and Cancel Forwarding.



- This feature is available to you only if you are using a Panasonic KX-T series telephone system with DPT Integration (see "DPT Integration" in the Glossary).

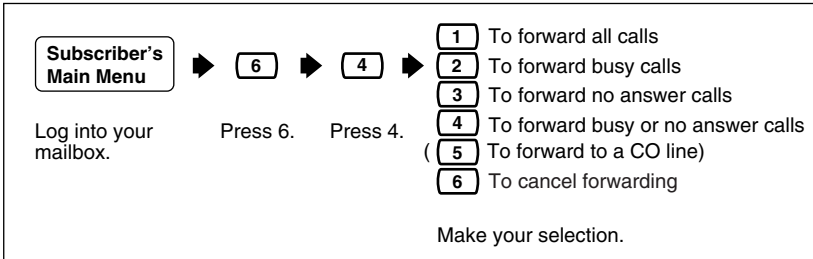

WHEN YOU PRESS 1, 2, 3, OR 4

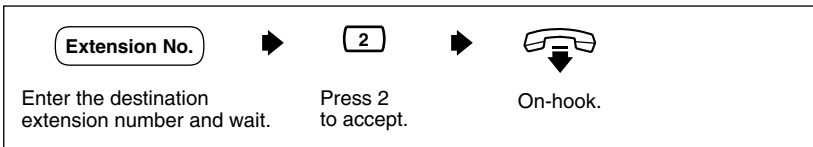

- You will hear " (5) To forward to a CO line" only when the System Administrator or the System Manager authorizes you the use of the Remote Call FWD to CO feature.
- If you hear "Call forwarding not accepted. Please check the destination number", the forwarding setting has not been completed properly at your telephone system, possibly because a nonexistent extension number has been entered as the destination. If you hear this message even though a valid number has been entered, consult your System Administrator.

WHEN YOU PRESS 5

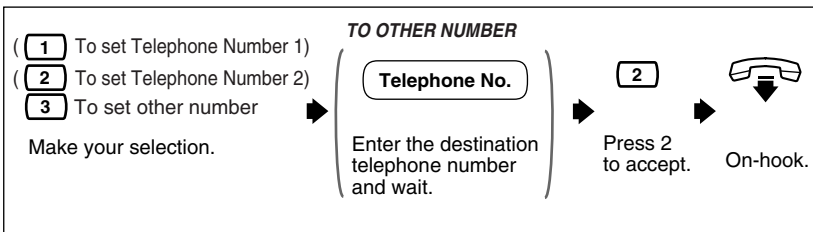



- Your System Administrator or System Manager must authorize this feature before it can be used.
- You must program Telephone number 1 and/or Telephone number 2 beforehand in Mailbox Management (See 4.15 Setting Telephone Numbers for Call Forwarding to CO); otherwise " **1** To telephone number 1" and/or " **2** To telephone number 2" will not be heard.
- Depending on your telephone system, you can enter up to 16 or 24 digits using the keys 0-9 and * for telephone numbers.
- Please make sure you begin the telephone number with a Line Access Code (to seize a CO line).

WHEN YOU PRESS 6

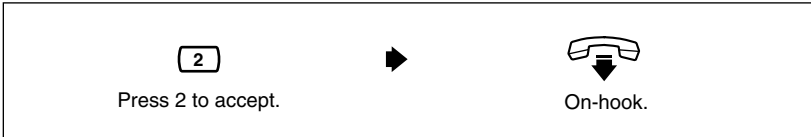

- Be sure to exit from the menu AFTER the forwarding setting is accepted; otherwise the forwarding setting will not be stored.

4.17 Setting Telephone Numbers for Call Transfer to CO

This feature allows you to assign telephone numbers as the destination to which callers are transferred if you enabled Call Screening or disabled All Transfer Service for Call Transfer Status (see 4.1 Call Transfer Status).



- If you cannot use this feature, ask your System Administrator or System Manager. She might have disabled it.

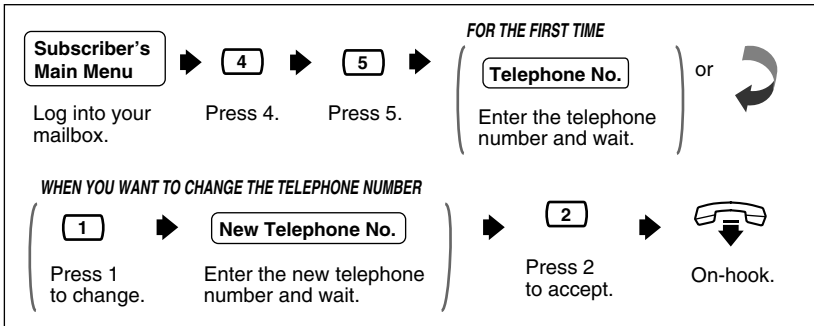

- Depending on your telephone system, you can enter up to 32 digits using the keys 0-9, *, and # for telephone numbers.
- Please make sure you begin the telephone number with a Line Access Code (to seize a CO line).
- **Important Note:** When the VPS calls to a CO line via a PRI (ISDN Primary Rate Access Interface) card of a Panasonic PBX, please be sure to add "#" after the telephone number (11 12223333 in the example here):
Example: 9P1112223333#
Please contact your System Administrator for more explanation.

4.18 Setting Telephone Numbers for Toll Saver

This feature allows you to assign up to 2 Caller ID numbers and a DID number for Toll Saver (see "Toll Saver" in the Glossary). When you check your mailbox from the assigned Caller ID numbers or by dialing the assigned DID number, the VPS notifies you whether or not there is a new message in your mailbox by changing the delayed answer time. You can reduce your telephone charges by accessing your mailbox only when there is a new message.



- DID number setting for this feature is only available when the VPS is connected to the following PBXs with DPT Integration (see "DPT Integration" in the Glossary).
 - KX-TD816 (P311Q or higher)
 - KX-TD1232 (P211Q or higher)
 - KX-TD500 (V4M or higher)
- If you cannot use this feature, cannot assign Caller ID numbers, or cannot assign a DID number, ask your System Administrator or System Manager. She might have disabled it.

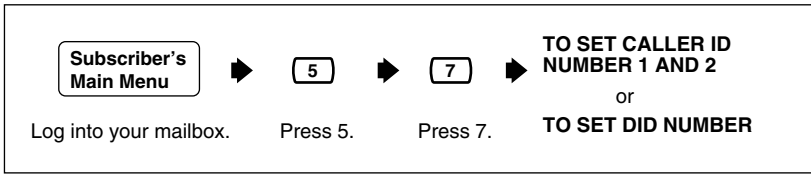

TO SET CALLER ID NUMBER 1 AND 2

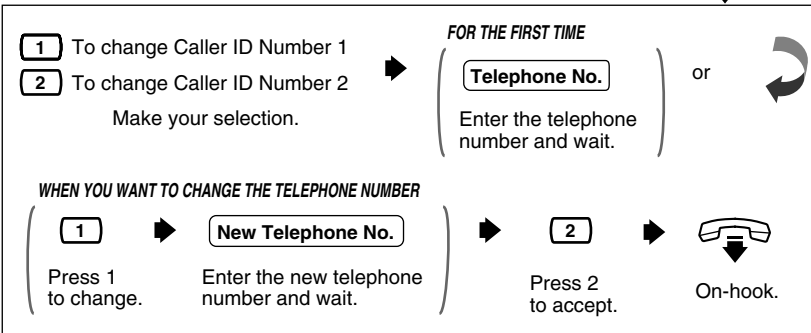

TO SET A DID NUMBER

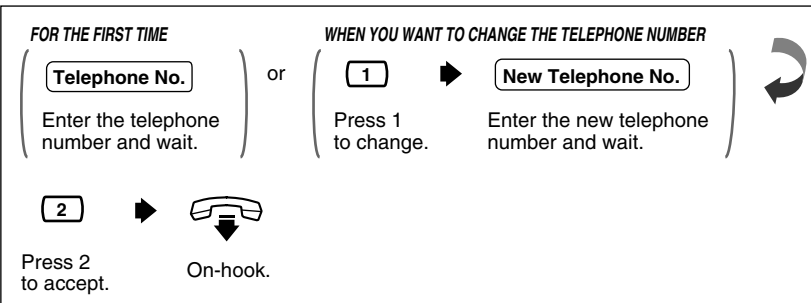

- Depending on your telephone system, you can enter up to 20 digits using the keys 0-9 and * for telephone numbers.
- Please make sure you begin the telephone number with a Line Access Code (to seize a CO line).

4.19 Setting Personal Custom Service

This feature allows you to set the following Custom Services in your personal greeting (Personal Custom Service):

- Transfer to Mailbox
- Transfer to Extension

- Transfer to Outside
- Custom Service (1 to 100)
- VM Service (Voice Mail Service)
- AA Service (Call Transfer Service)

A caller can select a desired service while listening to the personal greeting or recording a message.

You can also choose what happens if a caller does not dial anything after your personal greeting (No DTMF Input Operation) as follows:

- Message Recording—She will be guided to leave a message.
- Disconnect—The line will be disconnected.

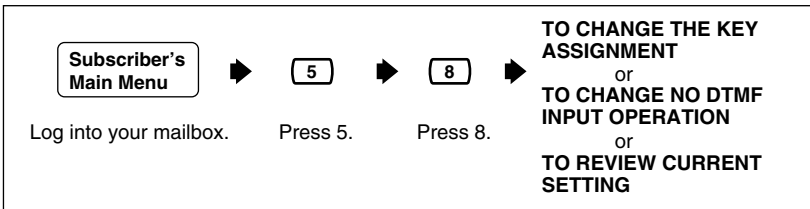

TO CHANGE THE KEY ASSIGNMENT

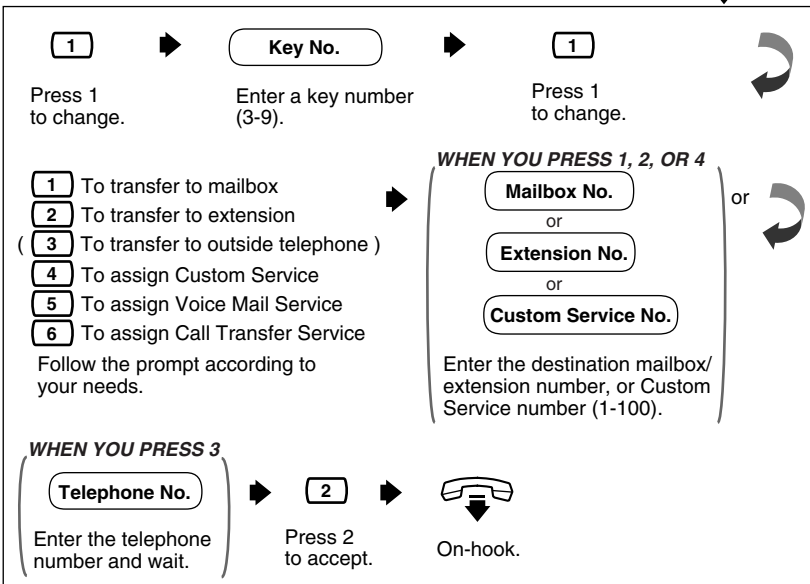

TO CHANGE NO DTMF INPUT OPERATION



TO REVIEW CURRENT SETTING



- You will hear " To transfer to outside telephone" only when the System Administrator or the System Manager authorizes you the use of the Call Transfer to Outside feature.
- Please note that your personal greeting should guide callers to select the preset Personal Custom Services easily.

[Example]

Personal Custom Service Settings

[3]: Transfer to outside telephone no. 1112223333 (Cindy's cell phone)

[4]: Transfer to extension no. 111 (Mr. Smith)

[5]: AA service (other extensions)

No DTMF Input Operation: Message Recording

Personal Greeting

"Hi, this is Cindy. Sorry, but I am away from my desk right now. Press [3] at any time to be transferred to my cell phone. Press [4] at any time to be transferred to Mr. Smith. Press [5] at any time for other extensions. If you want to record a message, just speak after the beep; press 1 when you are finished; and follow the system guidance instructions to leave your message in my mailbox".

- You can assign up to 2 keys for the Transfer to Outside.
- Please make sure you begin the telephone number with a Line Access Code (to seize a CO line).
- **Important Note:** When the VPS calls to a CO line via a PRI (ISDN Primary Rate Access Interface) card of a Panasonic PBX, please be sure to add "#" after the telephone number (1112223333 in the example here):
Example: 9P1112223333#
Please contact your System Administrator for more explanation.

A Appendix

A1 Quick Reference

Service Access Commands

Dial the following commands any time during system prompts to get a different mailbox, extension, or menu.

1	2	3
#1 Dial by Name	#2 Custom Service	#3 (#D) Department Dial
4	5	6
#5 (#L) Login	#6 (#M) Voice Mail	
7	8	9
#7 (#R) Restart (Main Menu)	#8 (#T) Transfer to Extn.	#9 (#X) Exit
*	0	#
* Return to Previous Menu	0 Help	# Help

Note: Commands #5 and #7 are available only when you have accessed Subscriber Service.

#5: Login

If you press #5 while in Subscriber Service, you will hear: "Please enter your party's mailbox number".

#7: Restart

If you press #7, while in Subscriber Service, you will return to the Main Menu (top menu) of Subscriber Service.

Set Call Transfer Status:	Incomplete Handling Status:	Record Personal Greeting:	Interview Mailbox Management:	Message Notification:	External Message Delivery:	Remote Call Forwarding Set:
1 Call Blocking 2 Call Screening 3 Intercom Paging 4 Beeper Access 5 Transfer to Mailbox 6 All Disable	1 Leaving a Message 2 Covering Extension 3 Intercom Paging 4 Beeper Access 5 Operator 6 Return to AA Service Top Menu	1 No Answer 2 Busy 3 After Hours 4 Caller ID	1 Record Question 2 Set Answer Length 3 Erase Question	1 Message Waiting Lamp 2 Device Status 3 Assign Telephone Numbers	1 Record message 2 Check Delivery Status 3 Set a Mailing List	1 FWD All Calls 2 FWD Busy Calls 3 FWD No Answer Calls 4 FWD Busy or No Answer Calls 5 FWD to a CO Line 6 FWD Cancel

Receive Message:	Deliver Message:	Check Mailbox Distribution:	Set AA Status:	Set Up Mailbox Management:	Set Other Features:
1 Repeat Message 1.1 Previous Message 2 Next Message 3 Erase Message 4 Send Reply 5 Rewind 6 Fast Forward 7 Transfer Message 8 Scan Messages 9 Save Message as New 0 Help	1 Enter Mailbox Number 2 Add Another Mailbox 3 Review Mailing List	1 Play Message 1.1 Check Previous Message 2 Check Next Message 3 Cancel	1 Set Call Transfer Status 2 Set Covering Extensions 3 Set Message Reception Mode 4 Set Incomplete Call Handling 5 Set Telephone Number for Transfer	1 Record Personal Greetings 2 Set Password 3 Enter Owner's Name 4 Set Group Distribution List 5 Record Caller Name/Number 6 Set Remote Call FWD to CO 7 Set Numbers for Toll Saver 8 Set Personal Custom Service	1 Set Interview Mailbox 2 Set Message Waiting Notification 3 Set External Delivery Message 4 Remote Call Forwarding Set

To Enter a Mailbox From a Remote Location, Dial: #6 *x+ mailbox number

→ Password #

→ Main Menu: You have * * * * new messages.

→

1 Receive message.
2 Deliver message.
3 Check Mailbox Distribution.
4 Set Automated Attendant (AA) Status.
5 Set Up Mailbox Management.
6 Set Other Features.
* Hang up.

Glossary

Alternate Extension Group

Transfers the call coming into the extensions in this group following the sequence specified by "Alternate Extension Transfer Sequence".

APT Integration

Digital Integration between the KX-TA624 and the VPS. APT Integration is only available for the KX-TVS95.

Auto Configuration

(Available with APT/DPT Integration only.) The VPS can automatically draw information from the KX-TA624, the KX-TD816, the KX-TD1232, the KX-TA1232, the KX-TD308, the KX-TD500, or the KX-TDA/KX-TAW series. This information includes, among other things, extension number assignments for each VPS port. This saves time in the initial setup. Auto Configuration can be executed by DIP/Rotary Switch settings or by System Administration (Quick Setup).

Auto Forwarding

Allows unretrieved messages to be copied or moved to another mailbox.

Automated Attendant

The Automated Attendant feature of the VPS requests the caller to enter an extension number and then the VPS dials the number. If there is no answer or the line is busy, the caller is given some options, including the option to leave a message in a mailbox. This is the advantage of calling an extension indirectly through the Automated Attendant rather than calling it directly.

Call Blocking

Connects the caller to the Incomplete Call Handling Service without ringing the subscriber's extension.

Call Screening

Allows subscribers to screen calls. The VPS prompts the caller with the message "Record your name at the tone", and records the caller's name; it then puts the caller on hold while playing the name to the subscriber who decides whether to take the call or not.

Call Transfer

Transfers a call to the requested destination.

Called Party ID

(Sometimes referred to as Follow-On ID) Allows the PBX to dial extra digits to bring the caller directly to a specified mailbox, rather than to the General Delivery Mailbox.

Caller ID Callback

Enables a subscriber to call back a message sender with the Caller ID number attached to the message.

Caller ID Call Routing

(Available with APT/DPT Integration only.) The VPS automatically sends calls from pre-assigned Caller ID numbers to the specified extension, mailbox (including System Group Distribution List) or Custom Service.

Caller Name Announcement (System/Personal)

(Available with APT/DPT Integration only.) The VPS announces prerecorded Caller ID caller's names when: (1) extension users listen to messages from pre-assigned numbers left in their mailboxes, (2) the VPS transfers calls from pre-assigned numbers to the users (Caller ID Screening), and (3) the VPS pages the users by intercom (Intercom Paging).

If the same Caller ID number is programmed for both system and personal caller name announcements, the VPS will use the personal caller name.

Company Greeting

Up to 32 Company Greetings can be recorded to greet callers. One (or System Greeting or none) can be selected for each Day, Night, Lunch, Break, and Holiday service on a port basis and trunk (CO line) basis.

Company Name

This is played by the VPS to the intended receiver of an External Delivery Message when she is unable to enter correctly the password (if required). This helps her to realize where the call came from.

Covering Extension

This can be a destination for Incomplete Call Handling Service. This can also be accessed by pressing [0] while a Personal Greeting is being played, or while a caller is leaving a message.

Custom Service Setting

Allows one-touch access to extensions, other custom service menus, fax machine, mailboxes, etc. A greeting can be recorded for each of the 100 menus to give verbal directions to the non-subscribers.

Default Setting

A parameter defined for the system at the factory which can be changed through system programming by the System Administrator or the System Manager.

Delayed Ringing

There are 2 kinds of delayed ringing applications:

- (1) The VPS is used as the no-answer destination for the Intercept Routing feature of your PBX.
- (2) DIL 1:N (CO line to several extensions) terminates on telephones and VPS ports. To give the telephone users a chance to answer calls, the VPS lines should be programmed for delayed ringing. Otherwise, the VPS will answer the calls immediately.

Delete Message Confirmation

The VPS requests confirmation from the mailbox owner before erasing a message left in the mailbox.

Delivery Time

The time specified by the subscriber for the VPS to deliver a prerecorded message. You can specify delivery time in External Delivery Message or when delivering a message to other subscribers (Subscriber's Guide Section 3.1).

Department Dialing

A speed-dialing feature that permits an outside caller to dial a single digit (1-9) to reach a specific extension.

DID Call Routing

(Available with DPT Integration only on the KX-TD816 [P311Q or higher], KX-TD1232 [P211Q or higher], and the KX-TD500 [V4M or higher].) The VPS automatically sends calls from pre-assigned DID numbers to the specified extension, mailbox (including System Group Distribution List) or Custom Service.

Direct Mailbox Access

(Available with APT/DPT Integration only.) A subscriber can enter her mailbox directly when she calls the VPS from her extension. She does not have to enter any special codes except for her password, if one is established.

DPT Integration

Digital integration between the VPS and the KX-TD816, the KX-TD1232, the KX-TA1232, the KX-TD308, the KX-TD500, or the KX-TDA/KX-TAW series. Requires upgraded software in the PBX.

Depending on the model and/or the software version of the connected PBX, you may not be able to utilize some of the features available only with DPT Integration. For more information, call National Parts Center at 1-800-833-9626.

DTMF

(Dual Tone Multi Frequency) Commonly referred to as touchtone.

Envelope Information Position

Specifies the position of Envelope Information—the name of the person who recorded/transferred a message, or Caller ID Number information.

Before: The VPS announces Envelope Information before playing the recorded/transferred message.

After: The VPS announces Envelope Information after playing the recorded message.

None: The VPS does not announce Envelope Information.

External Call Forwarding

(Available on the KX-TD816, the KX-TD1232, the KX-TA1232, the KX-TD308, the KX-TD500, and the KX-TDA/KX-TAW series.) Forwards calls to an extension that has call forwarding activated to an outside phone.

External Delivery Message

A message intended for automatic delivery to outside parties and/or extensions. The message can be delivered immediately or at a specified time.

External Message Delivery List

Allows the subscriber to create 2 lists to deliver messages to outside parties. Each list can have 8 destinations.

External Message Delivery Redial

Allows the System Administrator to instruct the VPS when making external message deliveries how many attempts to make when the line is busy or when there is no answer.

Fast Forward

Puts the user 4 s ahead in the current message.

Follow-On ID

See Called Party ID.

General Delivery Mailbox

When the caller does not dial anything (either because she does not want to or she is using a rotary telephone), the VPS sends her to the General Delivery Mailbox. Periodically (daily is best), the Message Manager should transfer the contents of the General Delivery Mailbox to the appropriate destinations.

Hash Sign

Same as Pound Sign.

HELP

One of the utility commands that is used to list all utility commands with a brief description of each.

Immediate Reply

Allows the message receiver to reply to a message without specifying the extension number or the mailbox number of the sender.

Inband Signaling

The Follow-On ID (or Called Party ID) that integrates the VPS and the PBX. Uses intercom paths to light message wait light. Does not give "high end" features such as: Intercom Paging, Direct Mailbox Access, Live Call Screening, etc.

Incomplete Call Handling Service

Calls are considered incomplete when there is no answer or if the line is busy. There are 6 options for the Incomplete Call Handling Service:

- (1) to record a message from the caller,
- (2) transfer the caller to a covering extension,
- (3) page the mailbox owner via the PBX,
- (4) notify the mailbox owner via beeper,
- (5) transfer the caller to the operator, or
- (6) let the caller try another extension.

Integration

Required between the VPS and the PBX. See Inband Signaling, APT Integration and DPT Integration.

Intercept Routing No Answer

Transfers an unanswered call to another extension, or to the VPS. (This is a PBX feature.)

Intercom Paging

(Available with APT/DPT Integration only.) Although Intercom Paging is generally paging through telephones ("internal paging"), paging through external speakers ("external paging") is also supported. Intercom Paging allows up to 16 different paging groups. An outside party can reach a subscriber who is away from her telephone using one of the paging groups that is assigned for the subscriber. (A paging group can be either internal or external.) For a Caller ID caller, if her name has been recorded for the Caller Name Announcement feature, the name will be announced at the end of the page.

Interview Service

A special type of subscriber mailbox that enables the subscriber to record up to 10 questions. After the answers are recorded, the Message Waiting Lamp turns on at the subscriber's telephone. (Good for claims departments, order desks, job applications, etc.)

Keypad

All touchtone keys on the telephone.

LCD

Liquid crystal display

Live Call Screening

(Available with APT/DPT Integration only.) The proprietary telephone works like an answering machine. The subscriber can hear the caller through the speakerphone or the handset while the message is being recorded.

LOAD

One of the utility commands that is used to load new or saved data to the VPS from a personal computer.

Logical Extension (All Calls Transfer to Mailbox)

An extension that always receives calls directly into its mailbox. This feature is used by subscribers who are often unavailable or who do not have a telephone.

Mailbox Capacity (messages)

The number of messages that can be recorded in a subscriber's mailbox: should be set between 5 and 100 messages by the System Administrator or the System Manager.

Mailbox Capacity (recording time)

The total length of time for messages in a subscriber's mailbox: should be set between 5 and 100 min or unlimited length by the System Administrator or the System Manager.

Mailbox Extension

Normally the same number as the telephone extension number.

Mailbox Management

Allows a subscriber to alter the setting for personal mailboxes.

Menu

A list of choices from which the user can select by using the telephone keypad or the keys from a personal computer.

Message Manager

(Mailbox 98, 998, 9998, or 99998) The person who takes care of the General Delivery Mailbox and records: the Company Greetings, Company Name, Department Dialing Menu, Custom Service Menus, Voice Labels, User Prompts (User 1/User 2), Multilingual Selection Menu, and System Caller Names.

Message Retention Time

New Message Retention Time—the length of time the VPS will store a new (unplayed) message before deleting the message.

Saved Message Retention Time—the length of time the VPS will store an old (played) message before deleting the message.

Message Retrieval Order

The order in which the subscriber retrieves messages: Last In First Out (LIFO) or First In First Out (FIFO).

Message Transfer

Allows a subscriber to reroute a message to another mailbox unless the message was marked "private". Additional comments can be added to this message.

Message Waiting Lamp

Light on proprietary telephones that lights when there are messages in the mailbox.

Message Waiting Notification

The VPS can notify subscribers and the Message Manager when they have received messages (if authorized by the System Administrator or the System Manager).

There are 3 notification methods: (1) by the Message Waiting Lamp, (2) by a telephone, or (3) by a beeper.

Multilingual Selection Menu

The Message Manager is responsible for recording this menu. Allows callers to choose the language they want (System, User 1 or User 2 prompts) when they call the VPS.

Non-Subscriber

A caller to the VPS who does not own a mailbox.

Notification Method

(See Message Waiting Notification.)

One-Touch Two-Way Transfer (One-Touch TWT)

(Available with DPT Integration only on the KX-TDA/KX-TAW series.) Allows a subscriber to record a conversation into another person's mailbox with one touch.

Operator

Up to 3 destinations can be assigned as operators. This is the extension that receives calls when the calling party is on a rotary phone or dials [0].

Owner's Name

After a subscriber records her name, the VPS announces her name during transfers, Intercom Paging, and confirmation of Dialing by Name.

Independent of this recording is registration of name by System Administrator.

This allows callers to dial parties by name (Dialing by Name) rather than by number.

For example, a caller can dial "S-M-I-T" (Smith) rather than Smith's mailbox number, which can be hard to remember.

Password

A combination of numbers selected by the subscriber to protect access to her mailbox. If forgotten, the System Administrator or System Manager can clear it so that the subscriber can select a new password.

Personal Custom Service

Allows a subscriber to set the following Custom Services in her personal greeting (Personal Custom Service):

- (1) Transfer to Mailbox
- (2) Transfer to Extension
- (3) Transfer to Outside
- (4) Custom Service
- (5) VM Service (Voice Mail Service)
- (6) AA Service (Call Transfer Service)

A caller can select a desired service from those above while listening to the personal greeting or recording a message.

Personal Greetings

A subscriber can record messages to greet callers. There are 3 kinds of Personal Greetings:

- (1) No Answer Greeting
- (2) Busy Signal Greeting
- (3) After Hours Greeting

Personal Greeting for Caller ID

(Available with APT/DPT Integration only.) Each subscriber can record up to 4 personal greeting messages for calls from pre-assigned Caller ID numbers. Each greeting supports up to 8 Caller ID numbers.

Personal Group Distribution List

A subscriber can maintain up to 4 distribution lists, each containing a maximum of 20 mailboxes. Using this list, she can send the same message to all members of a specific distribution list at once.

Port

The point of connection between the PBX and the VPS.

Pound Sign

The [#] key on the telephone keypad.

Private Message

A message recorded as a private message cannot be forwarded. You can specify privacy when delivering a message to other subscribers (Subscriber's Guide Section 3.1).

Prompt

Prerecorded VPS sentences that guide subscribers and non-subscribers through specific VPS functions. The VPS supports 3 prompts: (1) System prompts (prerecorded at the factory in English), (2) User 1 prompts*, and (3) User 2 prompts*. Prompts are numbered; the Message Manager can turn off and on the prompts individually.

* freely recorded by the Message Manager

Remote Call Forwarding Set

(Available with DPT Integration only.) A subscriber and the Message Manager can program her extension from a remote location to forward various types of calls to a desired extension or an outside telephone. There are 6 forwarding settings available:

- (1) Forward All Calls
- (2) Forward Busy Calls
- (3) Forward No Answer Calls
- (4) Forward Busy or No Answer Calls
- (5) Forward to a CO Line
- (6) Forward Cancel.

See Remote Call Forward to CO.

Remote Call Forward to CO

(Available with DPT Integration only.) Allows the System Administrator to program Telephone number 1 and Telephone number 2 as the destination to which the callers are forwarded when the Remote Call Forwarding is set to an outside (CO) line. This feature must be enabled in the COS (Class of Service) setting to be utilized. See Remote Call Forwarding Set.

Review

Plays back a message.

Rewind

Replays the last 4 s of a message.

Rotary Telephone

A telephone capable of pulse dial only. Callers using a rotary telephone will be automatically forwarded to the operator or the General Delivery Mailbox.

SAVE

One of the utility commands that is used to save VPS data to a personal computer.

Scanning Messages

Allows the subscriber to listen to only the first 4 s of each message. Another method is to press [2] while listening to a message; this instructs the VPS to skip to the next message.

Service Mode

The System Administrator or the System Manager can change the call handling method programmed in the Time Service setting.

Station (Personal) Programming

Programming via the proprietary telephone.

Subscriber

A person who has an assigned mailbox.

Subscriber Tutorial

When a subscriber accesses her mailbox for the first time, she will be guided to set up these items simply by following Help messages:

- (1) Password
- (2) Owner's Name
- (3) Personal Greetings (No Answer Greeting/Busy Greeting/After Hours Greeting)

System Administration

System programming can be performed via 2 ways: (1) Locally (personal computer connected directly to the RS-232C port of the VPS), or (2) remotely (personal computer connected via the telephone network, the external modem of the VPS, and internal modem card [KX-TVS325 only]).

Note: Local programming and remote programming are mutually exclusive.

System Administrator

Unlike the Message Manager and the System Manager, who use a telephone to perform their duties, the System Administrator uses a personal computer to program the VPS. The System Administrator's handbook is the Installation Manual.

System External Message Delivery Duration Time

The maximum time allowed for an external message that is to be delivered by the VPS, specified by the System Administrator.

System Group Distribution List

The VPS can maintain up to 20 distribution lists, each containing a maximum of 20 mailboxes. Each list is referenced by a System Group Distribution List number and is assigned via system administration. A recording into a System Group Distribution List number will go into the mailboxes of all group members.

System Manager

(Mailbox 99, 999, 9999, or 99999) The person who can perform very basic and limited system programming using a telephone. She can create/delete mailboxes, clear subscriber passwords when they are forgotten, set Class of Service parameters, set the System Clock, and generate System Reports.

System Report

The System Administrator or System Manager can generate 8 System Reports to monitor the VPS operating status as required.

System Security

By default, the System/Message Managers cannot access the VPS from their telephones until the System Administrator enables the relevant settings and sets a password for access. The System/Message Managers always need to enter this password to access the VPS.

The System Administrator can also choose to set a default password for subscribers' mailboxes. If this setting is enabled, a default password is automatically assigned when mailboxes are created.

TIME

One of the utility commands that is used to confirm or set the time and date of the VPS.

Time and Date Stamp Position

Specifies the position of Time and Date Stamp.

Before: The VPS announces Time and Date Stamp before playing the recorded/transferred message.

After: The VPS announces Time and Date Stamp after playing the recorded message.

None: The VPS does not announce Time and Date Stamp.

Time Group (KX-TVS125/KX-TVS225/KX-TVS325 only)

A time frame in which Day, Night, Lunch or Break time period can be programmed. It is possible to assign up to 8 different Time Groups.

Time Synchronization

(Available with DPT Integration only.) When the PBX sets a new date and time or when DPT Integration is established, the data is sent from the PBX to the VPS.

Toll Saver

Is a cost-saving feature that allows a subscriber to check her mailbox from a pre-assigned DID/Caller ID number without necessarily making the VPS answer the call. Without Toll Saver, the VPS will always answer the call and therefore she will incur toll charges. With Toll Saver, the VPS can let her know that there are no new messages without answering her call.

Two-Way Recording (TWR)

(Available with APT/DPT Integration only.) Allows a subscriber to record a conversation into her mailbox.

Two-Way Transfer (TWT)

(Available with APT/DPT Integration only.) Allows a subscriber to record a conversation into another person's mailbox.

Unlimited Message Length

Permits a mailbox owner to record two-way conversations of unlimited length into her or another person's mailbox (Two-Way Recording or Two-Way Transfer). The maximum recording time for other messages will automatically be set to 6 min.

Voice Mail

A general term used for messages recorded over the phone from one person to another.

Voice Prompt

Recorded VPS instructions to callers. These are either system prompts or user prompts.

VPS

Voice Processing System (e.g., Panasonic KX-TVS95, KX-TVS125, KX-TVS225, KX-TVS325).

**Panasonic Consumer Electronics Company
Division of Matsushita Electric Corporation of America**

One Panasonic Way
Secaucus, NJ 07094

**Panasonic Sales Company
Division of Matsushita Electric of Puerto Rico, Inc.**

Ave. 65 de Infantería, Km. 9.5
San Gabriel Industrial Park
Carolina, Puerto Rico 00985

<http://www.panasonic.com/csd>

Copyright:

This manual is copyrighted by Panasonic Communications Co., Ltd. (PCC). Under the applicable copyright laws, this manual may not be reproduced in any form, in whole or part, without the prior written consent of PCC and its licensee.

© 2004 Panasonic Communications Co., Ltd. All Rights Reserved.

PSQX3118ZA KK0204YK0